



i move^c

WER DIE WELT IN BEWEGUNG VERSETZEN WILL,
MUSS SICH SELBST BEWEGEN.

IN ORDER TO SET THE WORLD IN MOTION
YOU HAVE TO MOVE YOURSELF.

SOKRATES
(469-399 v. CHR.)





Arbeits-tisch: 180 x 90 cm
Oberfläche: Balearische Dekor
Säulenprofile: Aluminium gebürstet, farblos eloxiert
Fußschiene: Aluminium poliert
Höhenverstellbereich: 68 cm - 120 cm



Work station: 180 x 90 cm
Top: Balearic oak decor
Columns: aluminium brushed, clear anodised
Foot bars: aluminium polished
Height adjustment range: 68 cm - 120 cm



Arbeits-tische: 180 x 90 cm
Oberfläche: kristallweiß
Säulenprofile: Aluminium gebürstet, farblos eloxiert
Fußschienen: Aluminium poliert
Caddies & Sideboard: kristallweiß / orangerot

Work stations: 180 x 90 cm
Top: crystal white
Columns: aluminium brushed, clear anodised
Foot bars: aluminium polished
Caddies & sideboard: crystal white

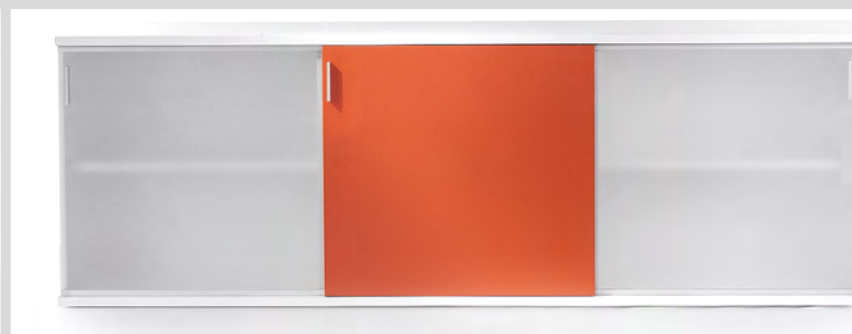



Besprechungstisch rund, Ø 100 cm
 Oberfläche: Ahorn Dekor
 Gestell: kristallweiß struktur
 Fußplatte: Chromeblending

*Round conference desk, Ø 100 cm
 Top: maple decor
 Frame: crystal white structure
 Foot plate: chrome blending*

Arbeitstisch angewinkelt: 245 x 141 cm
 Oberfläche: Ahorn Dekor
 Säulenprofile: kristallweiß struktur
 Fußschienen: Aluminium poliert
 Container: kristallweiß

*Angled work station: 245 x 141 cm
 Top: maple decor
 Columns: crystal white structure
 Foot bars: aluminium polished
 Pedestal: crystal white*





Arbeits-tisch: 180 x 90 cm
 Angeketteter Besprechungstisch, schwenkbar: Ø 100 cm
 Oberfläche: Baleareneiche Dekor
 Säulenprofile: Aluminium gebürstet, farblos eloxiert
 Fußschienen: Aluminium poliert



Work station: 180 x 90 cm
 Add-on-conference desk, swivelling: Ø 100 cm
 Top: Balearic oak decor
 Columns: aluminium brushed, clear anodised
 Foot bars: aluminium polished



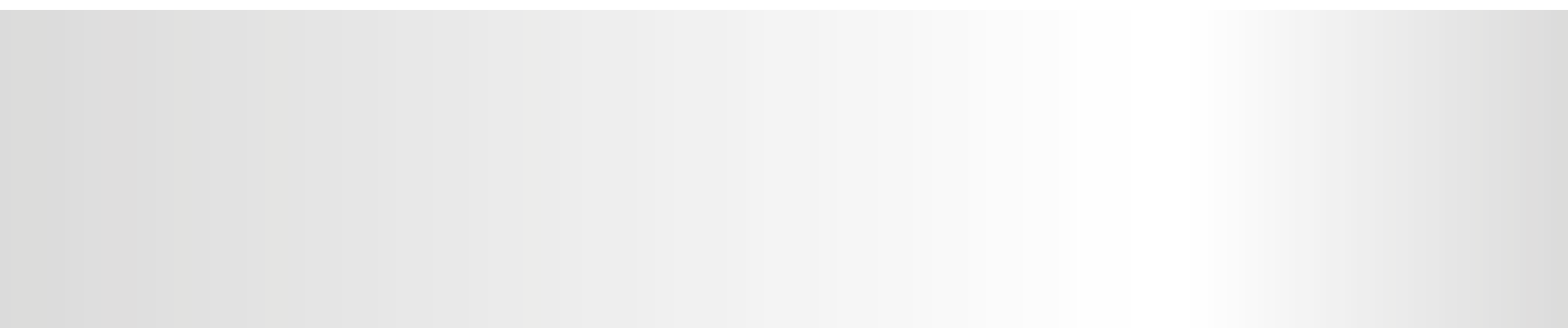

Arbeits Tisch: 203 x 90 cm

Oberfläche: Meeder Eiche Dekor

Säulenprofile: Aluminium gebürstet, farblos eloxiert

Fußschiene: Aluminium poliert

Lowboard (integriert): kristallweiß

Work station: 203 x 90 cm

Top: Meeder oak decor

Columns: aluminium brushed, clear anodised

Foot bars: aluminium polished

Lowboard (integrated): crystal white



Arbeitstisch, Eckform: 195 x 200 cm
 Oberfläche: kristallweiß
 Säulenprofile: kristallweiß struktur
 Fußschienen: kristallweiß struktur
 Caddy: Seitenteile in graphit,
 Oberboden, Rückwand und Blende
 vorne aus Metall in kristallweiß struktur

*Corner work station: 195 x 200 cm
 Top: crystal white
 Columns: crystal white structure
 Foot bars: crystal white structure
 Caddy: side parts: graphite
 top, back panel and front panel,
 made of metal: crystal white structure*



Arbeitstische: 180 x 80 cm
 Oberfläche: kristallweiß
 Säulenprofile: graphit struktur
 Fußschienen: silber struktur
 Schiebetüren-Anstellelemente:
 graphit / weißaluminium

*Work stations: 180 x 80 cm
 Top: crystal white
 Columns: graphite structure
 Foot bars: silver structure
 Side cupboard unit with sliding door:
 graphite / aluminium white*

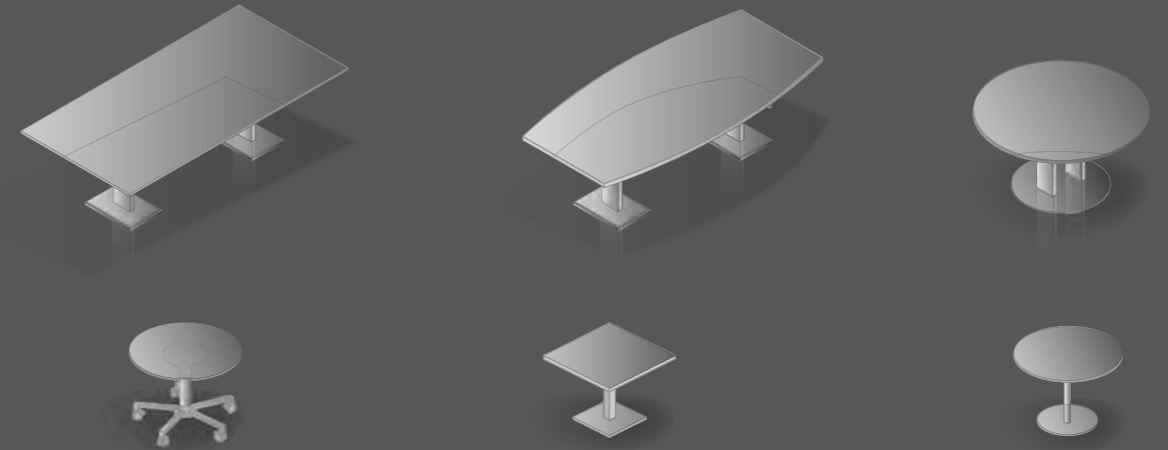

Verkabelung | cable management

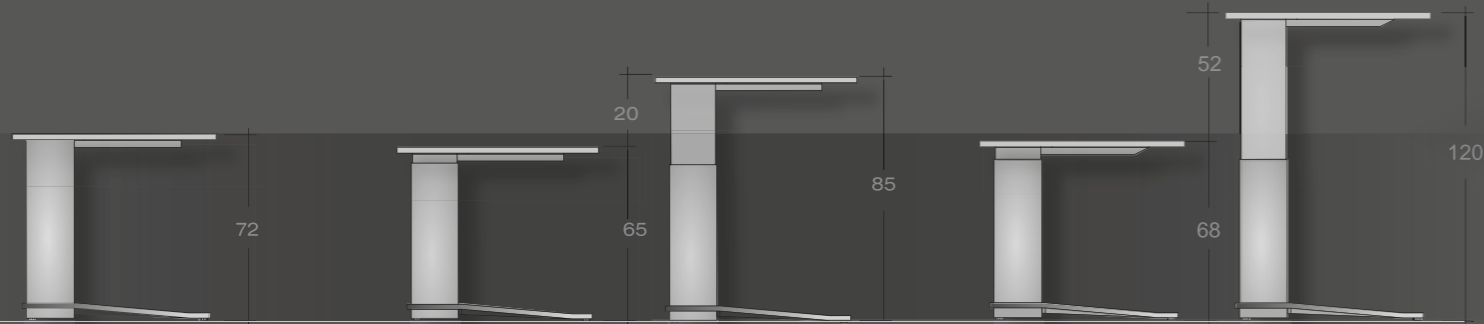
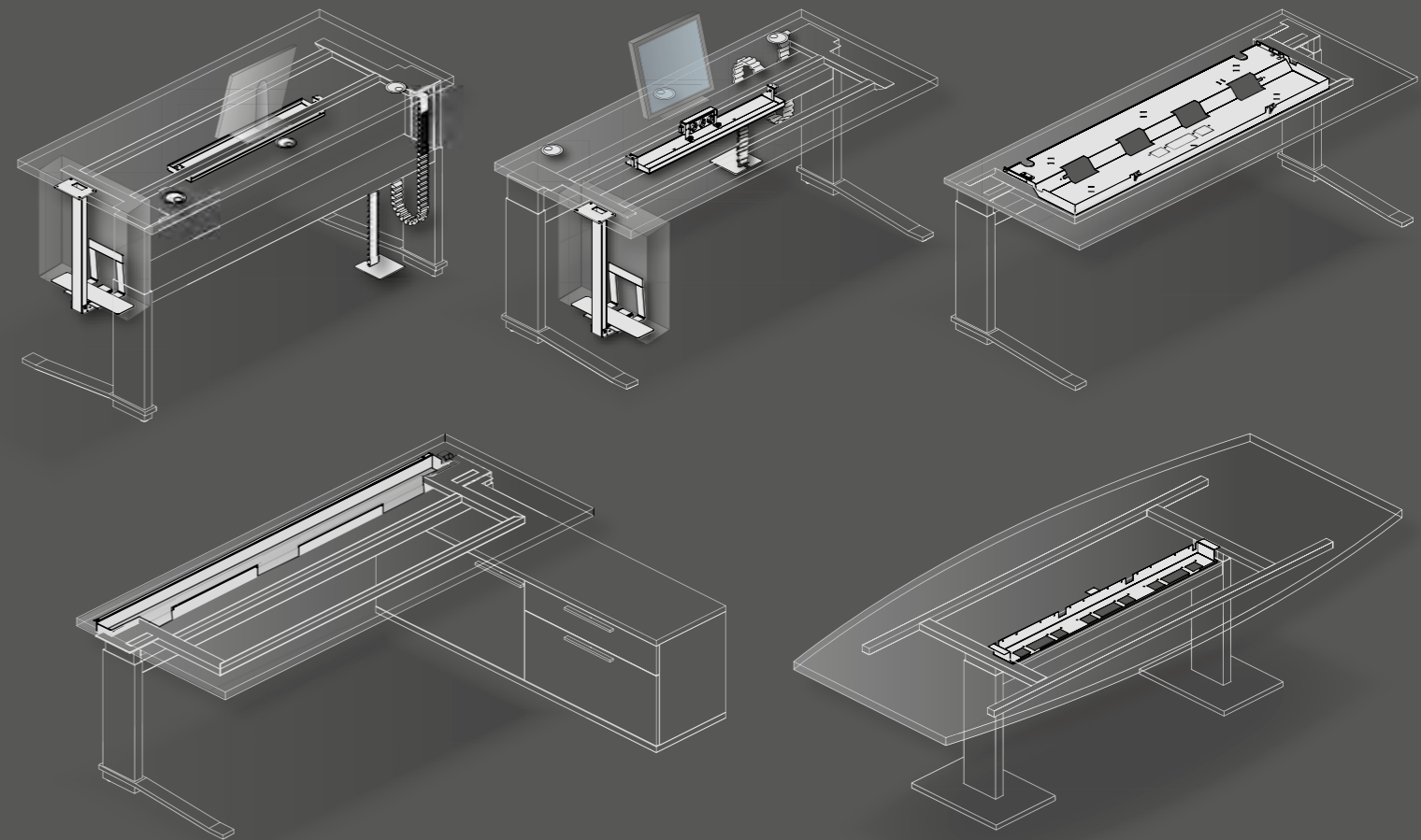

Arbeitsstisch starr 72 cm
work station fixed height

Arbeitsstisch höheneinstellbar 65-85 cm
work station initial height adjustable

Arbeitsstisch höhenverstellbar 68-120 cm
work station height adjustable

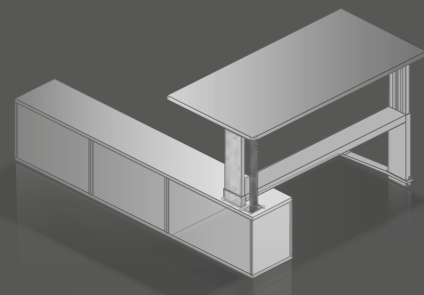
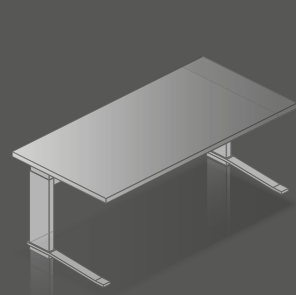

integriertes Lowboard
lowboard integrated

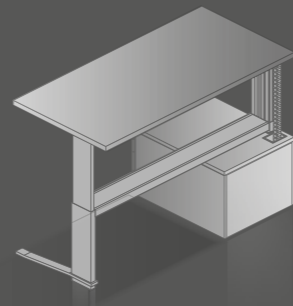

integrierter Technikcontainer
technical container integrated





Plattengrößen für Korpusunterbauten / sizes of tops for carcass

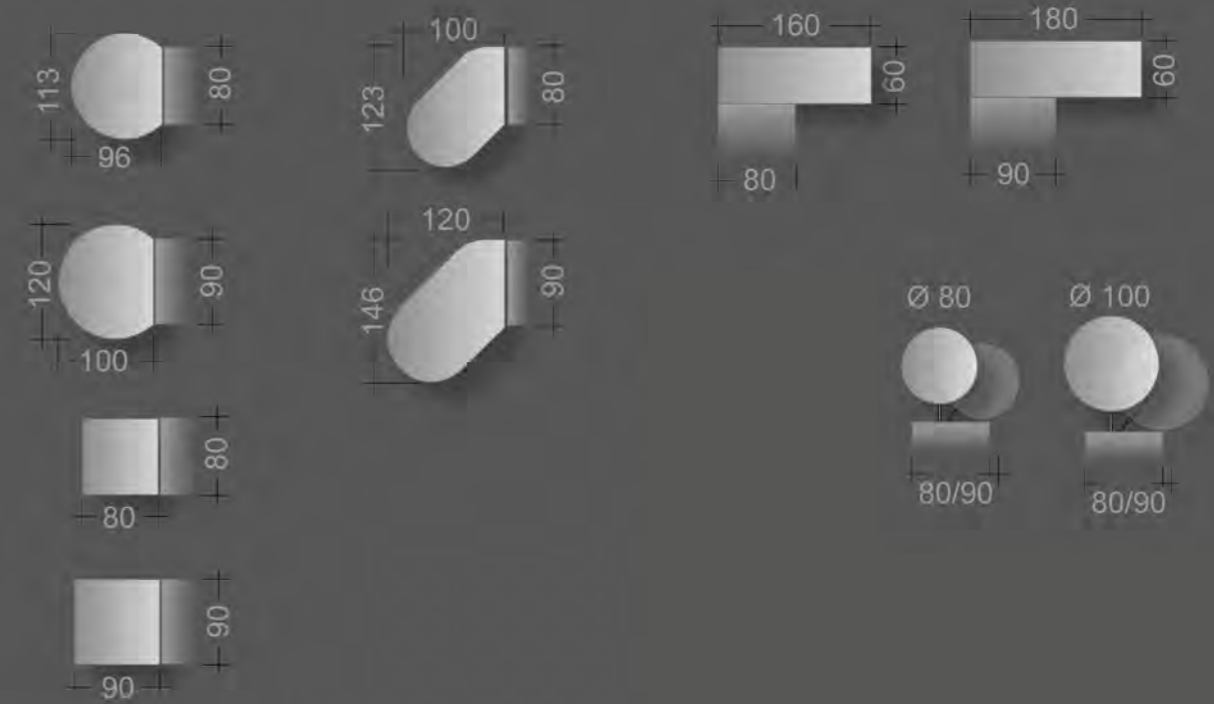
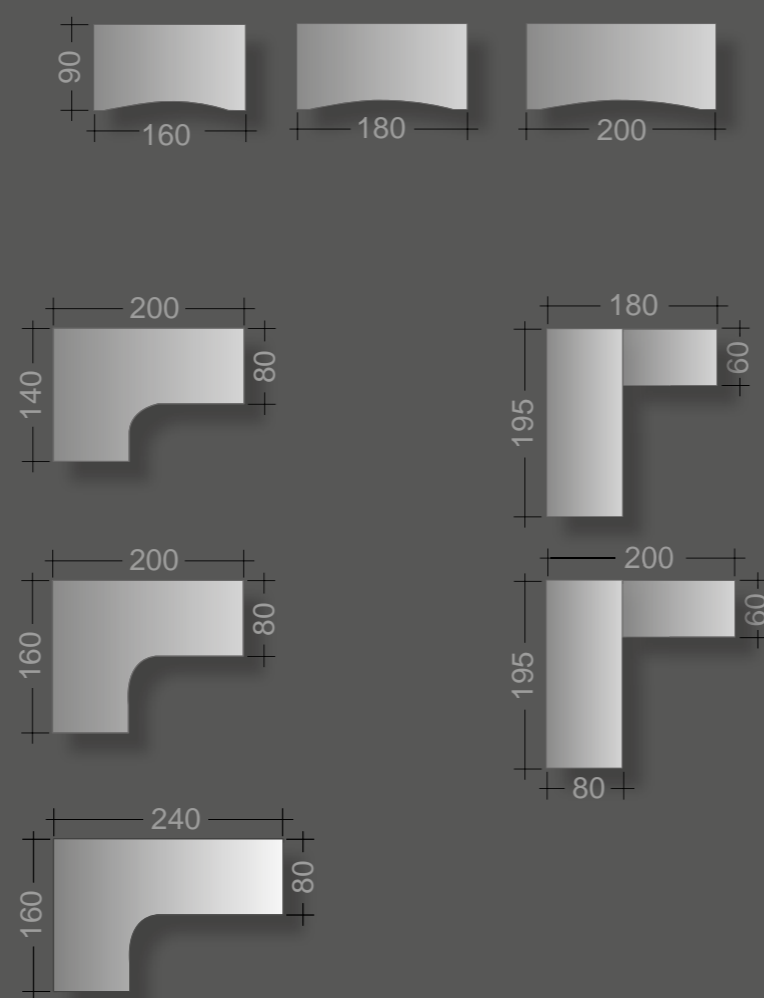
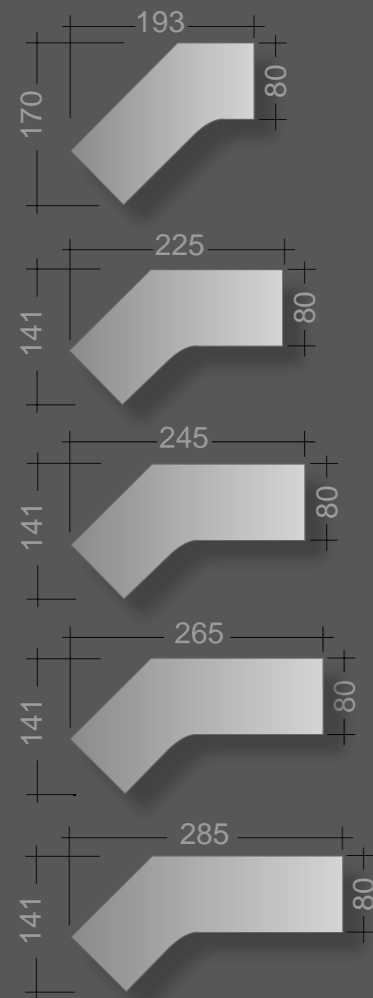

Besprechungstische | conference desks

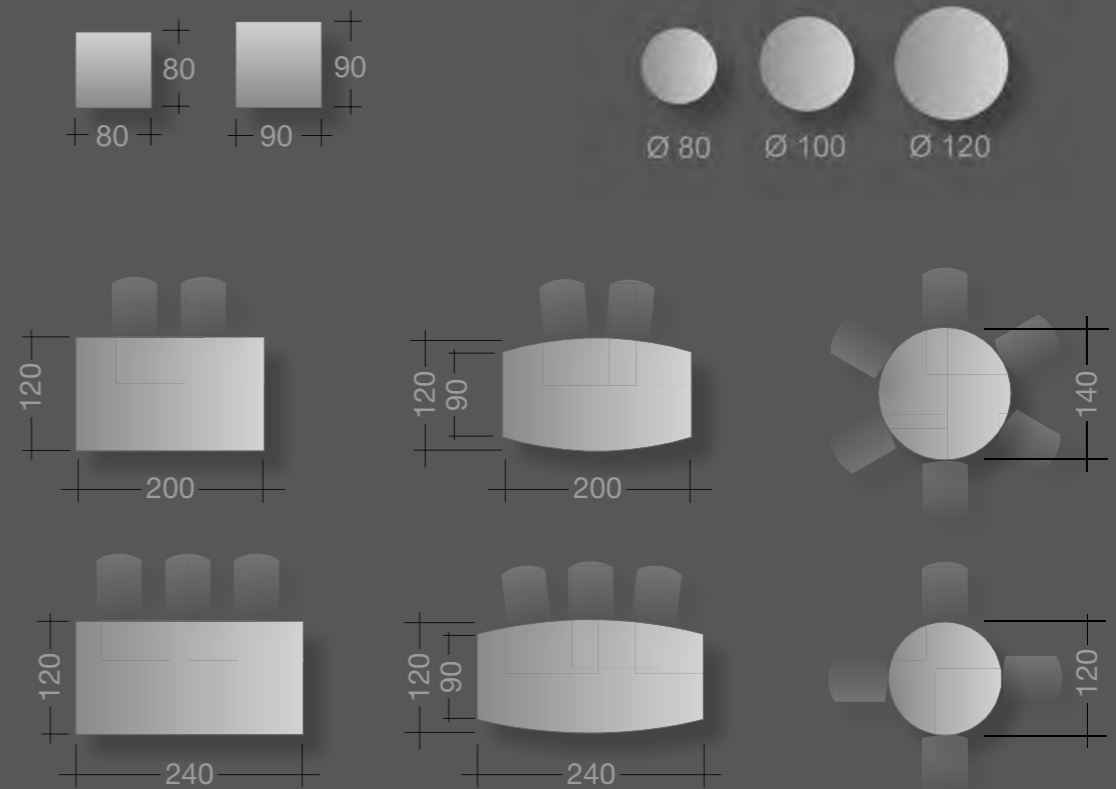



Arbeitsstisch: 160 x 80 cm
 Höhe: 72 cm (starr)
 Oberfläche: Rodach Eiche Dekor
 Säulenprofile: Aluminium gebürstet, farblos eloxiert
 Fußschienen: Silber struktur
 Work station: 160 x 80 cm
 Fixed height 72 cm
 Top: Rodach oak decor
 COLUMNS: aluminium brushed, clear anodised
 Foot bars: silver structure



Arbeitsstisch: 160 x 80 cm
 höhenstellbar 65 - 85 cm
 Oberfläche: Rodach Eiche Dekor
 Säulenprofile: Aluminium gebürstet, farblos eloxiert
 Fußschienen: Silber struktur
 Work station: 160 x 80 cm
 Initial height adjustable 65 - 85 cm
 Top: Rodach oak decor
 COLUMNS: aluminium brushed, clear anodised
 Foot bars: silver structure



Arbeitsstische: 160 x 80 cm
 Oberfläche: weißaluminium
 Gestell: graphit struktur
 Motorische Höhenverstellung M2: 68 cm - 120 cm
 Work stations: 160 x 80 cm
 Top: aluminium white
 Frame: graphite structure
 Height adjustment by motor M2: 68 cm - 120 cm





Besprechungstisch Freiform: 240 x 120 cm

Oberfläche: kristallweiß

Gestell: kristallweiß struktur

Fußplatte: Chromeblending

Höhenverstellbereich: 74 cm - 126 cm

Free form conference desk: 240 x 120 cm

Top: crystal white

Frame: crystal white structure

Foot plate: chrome blending

Height adjustment range: 74 cm - 126 cm





Besprechungstisch rund: Ø 140 cm *Round conference desk: Ø 140 cm*
 Oberfläche: Echtholz Nussbaum *Top: walnut veneer*
 Gestell: Aluminium gebürstet farblos eloxiert *Frame: aluminium brushed, clear anodised*
 Fußplatte: Chromblendung *Foot plate: chrome blending*
 Höhenverstellbereich: 71 cm - 123 cm *Height adjustment range: 71 cm - 123 cm*



Besprechungstisch rechteckig: 240 x 120 cm *Rectangular conference desk: 240 x 120 cm*
 Oberfläche: Echtholz Eiche *Top: oak veneer*
 Gestell: kristallweiß struktur *frame: crystal white structure*





Arbeits-tisch: 223 x 90 cm

Oberfläche: kristallweiß

Säulenprofile: Aluminium gebürstet, farblos eloxiert

Fußschiene: kristallweiß struktur

Höhenverstellbereich: 68 cm - 120 cm

Technikcontainer: kristallweiß

Work station: 223 x 90 cm

Top: crystal white

Columns: aluminium brushed, clear anodised

Foot bar: crystal white structure

Height adjustment range: 68 cm - 120 cm

Pedestal for files and hardware: crystal white





Arbeitsfläche: 183 x 90 cm
 Oberflächen: kristallweiß
 Säulenprofile: Aluminium gebürstet, farblos eloxiert
 Fußschienen: Aluminium poliert
 Lowboards (Spezialbreite): kristallweiß
 Höhenverstellbereich: 68 cm - 120 cm

Work stations: 183 x 90 cm
 Tops: crystal white
 Columns: aluminium brushed, clear anodised
 Foot bars: aluminium polished
 Lowboards (special width): crystal white
 Height adjustment range : 68 cm - 120 cm





Arbeitstisch: 183 x 90 cm

Oberfläche: kristallweiß

Säulenprofile: Aluminium gebürstet, farblos eloxiert

Fußschiene: kristallweiß struktur

Lowboard: kristallweiß

Work station: 183 x 90 cm

Top: crystal white

Column: aluminium brushed, clear anodised

Foot bar: crystal white structure

Lowboard: crystal white

Impressum:

*Design iMOVE: Michael Wirsing
Design iSCUBE: André Vormdran*

*Realisation & Graphic Design:
ehlers-media.com*

*Fotografie:
Rolf Nachbar u. Michael Ehlers*

*Gemälde & Zeichnungen:
Prof. Wolfgang Fischer*

*Änderungen vorbehalten. Farben können von den Originalen abweichen.
Subject to change without notice. Colours may vary from actual material.*





Österreich

BEWEGT ●●●●●●●●●●●●●●●●●●●●

Leuwico Büroeinrichtungen GmbH | office@leuwico.at | +43 732 671793-0
Johann – Roithner - Str. 131 | A-4050 Traun b. Linz | IMG - Business Center, Objekt A
www.leuwico.at



2019-03